

E13A

5MP with Basic WDR, Fixed Lens



- 5 Megapixel
- Fixed Lens with f2.8mm/F2.0
- Basic WDR
- Wide Angle
- Event trigger, response and notification

► Specifications

Device

Product Type	Cube
Maximum Resolution	5MP
Application Environment	Indoor
Image Sensor	Progressive Scan CMOS
Sensor Size	1/3.2 "
Effective Pixels	2592(H) X 1944(V) (5.04 MP)
Day / Night	No
Low Light Sensitivity	Standard
Minimum Illumination	Color: 0.1 lux at F2.0 (30 IRE, 2400 K)
Mechanical IR Cut Filter	No
IR LED	No
Electronic Shutter	1/5-1/2000 second (manual mode); 1/5-1/10000 second (auto mode)
Horizontal Resolution (TV Lines)	1350 TVL
S/N Ratio	52 dB

Lens

Focal Length	Fixed focal, f2.8mm
--------------	---------------------

Aperture	F2.0
Iris	Fixed iris
Focus	Manual focus
Lens Mount	CS Mount (interchangeable lens)
Horizontal Viewing Angle	92.6°
Vertical Viewing Angle	69.8°

Video

Compression	H.264 (Baseline/ Main/ High profile), MJPEG
Maximum Frame Rate vs. Resolution	15 fps at 2592 x 1944 15 fps at 2048 x 1536 30 fps at 1920 x 1080 30 fps at 1280 x 720 30 fps at 800 x 600 30 fps at 640 x 480 15 fps at 320 x 240
Multi-Streaming	Simultaneous dual streams based on two configurations
Bit Rate	28Kbps - 6Mbps (per stream)
Bit Rate Mode	Constant, Variable
Wide Dynamic Range	Basic WDR (74 dB)
Image Enhancement	White Balance, Brightness, Contrast, Sharpness, Automatic gain control, Flickerless
Digital Noise Reduction	DNR
Privacy Mask	4 configurable regions
Text Overlay	Yes
On-Screen Graphics	Yes
Server-based Analytics	Object Line Counting, People Counting, Face Detection, Object Based Motion Detection, Tamper, Object Line Crossing Detection, Object Enter Area Detection, Missing Object Detection, Unattended Object Detection, Smoke Detection, Heat Map, Dwell Time, People Queue Detection, (Require PC-based or standalone IVS or ALPR Server. Contact ACTi support for recommendations on how to maximize analytical accuracy)
Image Orientation	Flip, Mirror

Audio

Audio Type	2-way, Built-in Microphone, Line-out
Audio Compression	8 kHz, 16 bit encoding, Mono, PCM, G.711

Network

Network Protocol & Service	IPv4/v6, TCP, UDP, DHCP, PPPoE, HTTP, HTTPS, DNS, DDNS, NTP, RTP, RTSP, RTCP, SMTP, FTP, IGMP, ICMP, ARP, Bonjour, UPnP, QoS, SNMP, IEEE 802.1X
Ethernet Port	1 x RJ-45 connector
Security	IP address filtering, HTTPS encryption, Password protected user level, Anonymous login, IEEE 802.1X network access control

Event

Event Trigger	Video motion detection (3 regions), Sound detection,
Event Response	Notify control center, Change camera settings, Command other devices, E-mail notification with snapshots, Play the audio file, Push notification to mobile device, Save video to local storage, Upload video or snapshot to FTP server, Upload video to NVR server

Integration

Unified Solution	Fully compatible with ACTi software
------------------	-------------------------------------

Software Development Kit	Yes
GPS Position	Manual setting
ONVIF Compliant	Yes, Profile S, Profile G, Profile T* (To be available through future firmware upgrade), Profile Q
GB28181 Compliant	Yes
Web Browser	IE 11
Auto Firmware Upgrade	Yes

Interface

Audio Interface	Built-in microphone, 3.5mm Phone Jack
Local Storage	MicroSDHC, MicroSDXC memory card slot (card not included)

General

Power Source	PoE Class 2 (IEEE802.3af)
Power Consumption	3.552 W (PoE)
Weight	241g (0.53lb)
Dimensions	(W x H x D): 96mm x 96mm x 45.07mm (3.8" x 3.8" x 1.8")
Environmental Casing	No
Bundled Accessories	Bracket
Mount Type	Bracket
Starting Temperature	-10°C ~ 45°C (14°F ~ 113°F)
Operating Temperature	-10°C ~ 45°C (14°F ~ 113°F)
Operating Humidity	10% - 85% RH
Approvals	CE, FCC, UL (for optional PoE injector)
Warranty	3 Year(s). For extended warranty offering, see http://www.acti.com/support/warranty

▶ Photo Indication

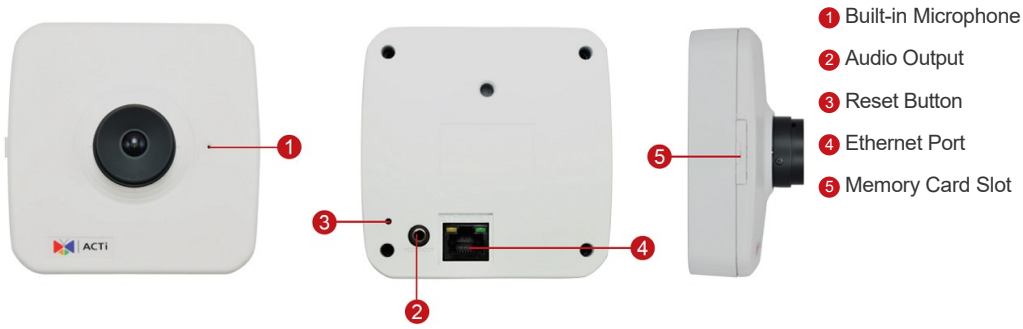

▶ Dimension Diagram

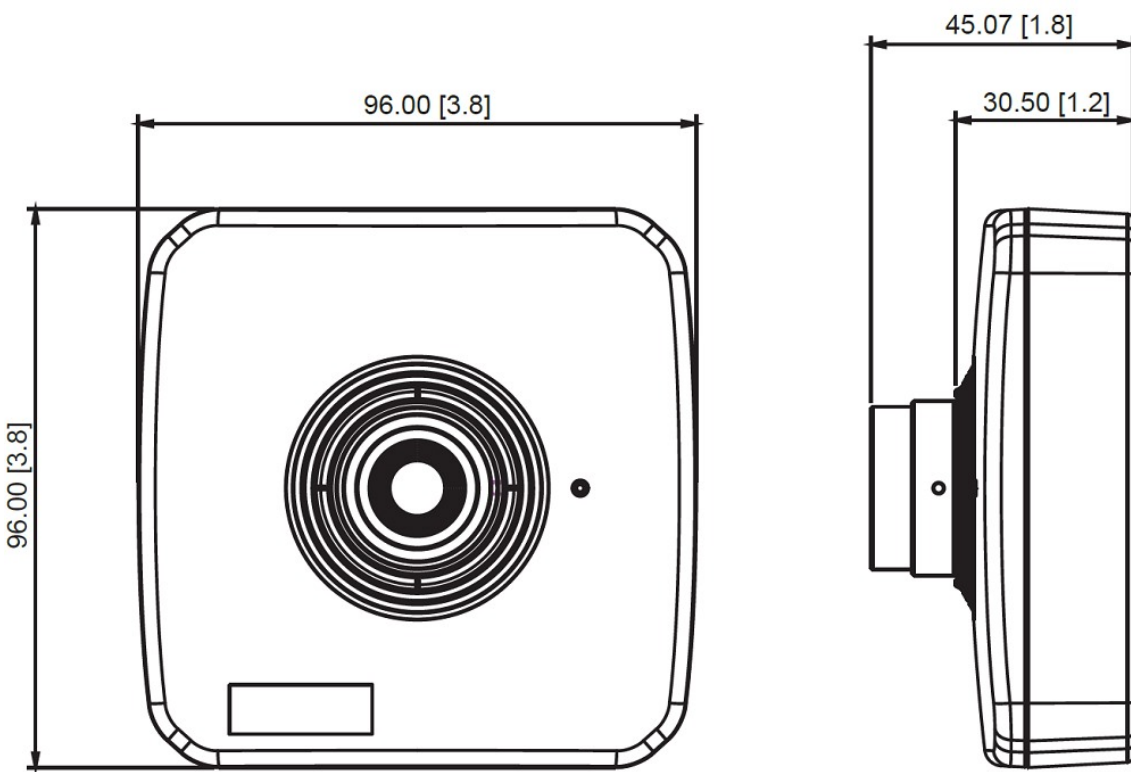



Unit: mm [inch]

▶ Related Products







Lenses - Fixed Lens

PLEN-0101		Fixed Focal f4.2mm, Fixed Iris F1.8, Manual Focus, D/N, Megapixel, CS Mount Lens
PLEN-0119		Fixed Focal f2.8mm, Fixed Iris F2.0, Manual Focus, D/N, Megapixel, CS Mount Lens

Power Supply Accessories - PoE Injector

PPOE-0000		PoE Injector , IEEE 802.3af compliant, AC 100~240V, for US & Japan
PPOE-0001		PoE Injector IEEE 802.3af compliant, AC 100~240V, with universal connectors

Network & Storage Peripherals - Data Switch

PPSW-0100		PLANET FGSD-910HP 8-Port 802.3at PoE Switch (PoE Budget 120W)
PPSW-0101		PLANET GS-4210-8P2T2S 8-Port Gigabit 802.3at Managed PoE Switch (PoE Budget 240W)
PPSW-0102		PLANET FGSD-1011HP 8-Port 802.3at PoE Switch (PoE Budget 120W)
PPSW-1101		PLANET GS-4210-24PL4C 24-Port Gigabit 802.3at Managed PoE Switch (PoE Budget 440W)
PPSW-2101		4-Port 802.3at PoE Switch (PoE Budget 62W)
PPSW-3100		PLANET FGSW-1816HPS 16-Port 802.3at PoE Switch (PoE Budget 220W)

Extenders - PoE Extender

PPEX-0100		Veracity OUTREACH Max Power over Ethernet (PoE) Extender
-----------	---	--

Extenders - PoE over Coaxial Extender Kit

PPOC-0100		Planet LRP-101C-KIT Power over Coax Adapter Kit
-----------	---	---

Product Demo - Camera Demo Kit

PCDK-0001		Camera Demo Kit Rack Box (350 x 550 x 140 mm) for all cameras except Mini Domes
-----------	---	---

Installation Support - Camera Installation Kit

PMON-1001-010		Camera Installation Kit for use with iOS Device with belt bag, battery and charger (US, AC 110~240V)
---------------	---	--

PMON-1001-011



Camera Installation Kit for use with iOS Device with belt bag, battery and charger (Europe, AC 110~240V)

PMON-2000



Camera Installation Kit